



Benner-Nawman, Inc.

3450 Sabin Brown Road • Wickenburg, AZ 85390

(800) 992-3833 • (928) 684-2813 • www.bnproducts.com

Specification Sheet

Part #
30369W-UL

This Cabinet Measures:
30" Wide x 36" Tall x 9" Deep

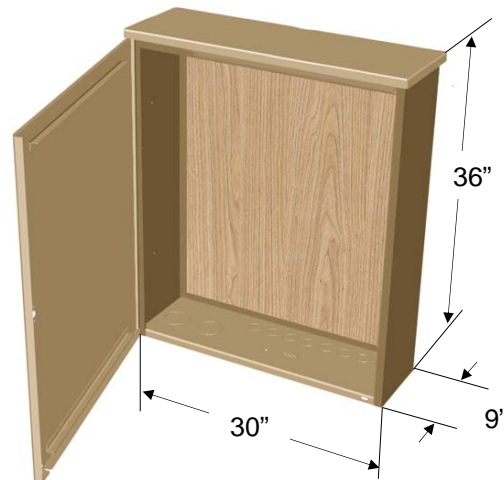

Features & Info:

- Includes $\frac{3}{4}$ " plywood backboard & 4-position, #4-14 wire ground bar mounted inside
- Includes 2 knockouts $2\frac{1}{2}$ " - $3\frac{1}{2}$ " (for 2" - 3" conduit) & 8 knockouts $1\frac{3}{8}$ " - $1\frac{3}{4}$ " (for 1" - $1\frac{1}{2}$ " conduit) See Chart Below
- Made of 14-gauge zinc-coated steel w/ a desert tan powder coat finish
- Reinforced hinged lid with $\frac{7}{16}$ " recessed hex latch
- "COMMUNICATIONS" embossed on the cover
- UL-Listed (UL1863), designed to NEMA 3R
- Includes 2 J-hooks for mounting
- Box weight: 105 lbs.

This enclosure is also available with a splice chamber

Knockout Pattern

